



WORKY®

MOBILE UNITS

UNITÀ MOBILI

UNITEES MOBILES

FAHRBARE GERATE

UNIDADES MOVILES



DMOB2
Pag. 4



DT2M
Pag. 8



DMOB2

 Il DMOB2 di WORKY è un aspiratore mobile progettato per la rimozione efficiente delle polveri di carteggiatura in carrozzeria.

È dotato di doppio motore per 2 operatori in simultanea e garantisce alta efficienza, un ambiente pulito e conforme alle normative. La struttura robusta, montata su ruote industriali, assicura facilità di movimentazione e resistenza all'uso intensivo. Ideale per applicazioni professionali, combina mobilità, prestazioni e affidabilità in un'unica soluzione compatta.

 The WORKY DMOB2 is a mobile vacuum cleaner designed for the efficient removal of sanding dust in body shops.

It is equipped with a dual motor for simultaneous use by two operators and guarantees high efficiency and a clean, compliant environment. Its sturdy structure, mounted on industrial wheels, ensures ease of movement and resistance to intensive use. Ideal for professional applications, it combines mobility, performance and reliability in a single compact solution.

 Le DMOB2 de WORKY est un aspirateur mobile conçu pour éliminer efficacement les poussières de ponçage dans les ateliers de carrosserie. Il est équipé d'un double moteur permettant à deux opérateurs de travailler simultanément et garantit une grande efficacité, un environnement propre et conforme aux normes. Sa structure robuste, montée sur des roues industrielles, assure une grande maniabilité et une résistance à un usage intensif. Idéal pour les applications professionnelles, il allie mobilité, performances et fiabilité dans une solution compacte unique.

 Der DMOB2 von WORKY ist ein mobiler Staubsauger, der für die effiziente Entfernung von Schleifstaub in Karosseriewerkstätten entwickelt wurde. Er ist mit einem Doppelmotor für zwei Bediener gleichzeitig ausgestattet und garantiert hohe Effizienz, eine saubere Umgebung und die Einhaltung der Vorschriften. Die robuste Konstruktion auf Industrierädern gewährleistet eine einfache Handhabung und Widerstandsfähigkeit bei intensiver Nutzung. Ideal für professionelle Anwendungen, vereint er Mobilität, Leistung und Zuverlässigkeit in einer einzigen kompakten Lösung.

 El DMOB2 de WORKY es un aspirador móvil diseñado para la eliminación eficaz del polvo de lijado en talleres de carrocería. Está equipado con un motor doble para que puedan trabajar dos operarios simultáneamente y garantiza una alta eficiencia, un entorno limpio y el cumplimiento de la normativa. Su estructura robusta, montada sobre ruedas industriales, garantiza una fácil manipulación y resistencia al uso intensivo. Ideal para aplicaciones profesionales, combina movilidad, rendimiento y fiabilidad en una única solución compacta.







DMOB2

 Unità mobile per l'aspirazione e la filtrazione di polveri di carteggiatura. Dotata di 2 motori da 1000 W, selettore di potenza, 2 prese elettriche shuko, 2 attacchi rapidi aria compressa, filtro a sacco in cellulosa. Partenza automatica dell'aspirazione dall'utensile.

 Mobile unit for dry sanding dust extraction and filtration equipped with 2 engines 1000 W each, regulator for the required power, 2 shuko sockets 230V, 2 quick couplings for compressed air, bag cellulose filter. Automatic extraction start and stop from the tool.

 Unité mobile pour l'extraction et la filtration des poussières de ponçage. Avec 2 moteurs de 1000 W, interrupteur, 2 prises Schuko, 2 connexions rapides de l'air comprimé. Démarrage automatique de l'aspiration.

 Mobiles Gerät für Schleifstaubabsaugung und -Filtration. Mit 2 Motoren von 1000 W Leistung, Wahlheber, 2 Schuko-Steckdosen, 2 Druckluftanschlüsse, Beutelfilter. Automatischer Start und Stop der Absaugung durch Werkzeug.

 Equipo móvil para extracción y filtración de polvo de lijado. Equipado con 2 motores de 1000 W, selector de potencia, 2 tomas eléctricas 230V, 2 enchufes rápidos para aire comprimido, filtro en bolsa. Paro y arranque automático.



DMOB2	Kw	V	Hz	m3/h	mm H ₂ O	m ²	dB	Auto start
DMOB2	1+1	230	50/60	260	2000	2,1	72	Electr. - Pneum.
DMOB2E	1+1	230	50/60	260	2000	2,1	72	Electr.



via Masaccio, 15
 42124 Reggio Emilia (RE) ITALY
 Tel. +39 0522 1545193
 vendite@worky-italy.com
 sales@worky-italy.com

www.worky-italy.com

DMOB2 - technical datasheet

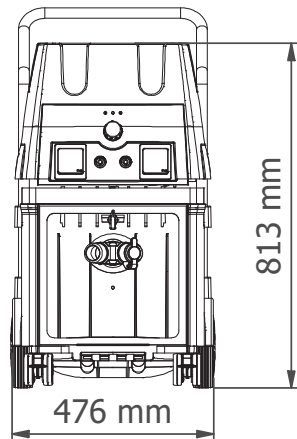
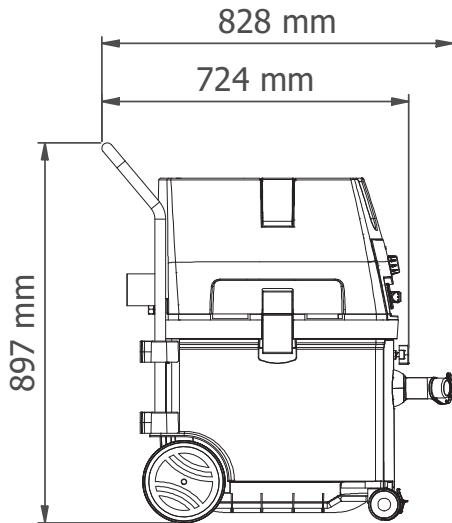
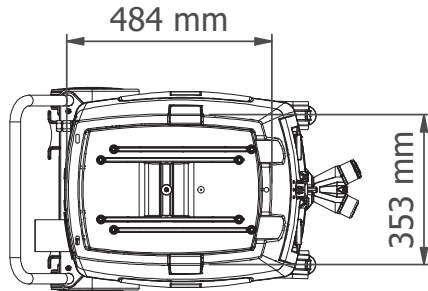

COD	Kw	V	Hz	m ³ /h	mm H ₂ O	m ²	Db	AIR connection	Auto Start	PACK			Kg Tot
										l [mm]	w [mm]	h [mm]	
DMOB2	1+1	230	50/60	220-260	2000	2,1	72	3/8" F	Electr. - Pneum	750	550	950	37
DMOB2E	1+1	230	50/60	220-260	2000	2,1	72	3/8" F	Electr.				

THIS DRAWING IS PROPERTY OF DEA + RO & Co S.p.A. THE COMPLETE OR PARTIAL REPRODUCTION OF THIS DOCUMENT IS FORBIDDEN. THE OWNER RESERVES THE RIGHT TO UPDATE, MODIFY OR AMEND ANY SPECIFICATION WITHOUT PRIOR NOTICE.

Rev.00

1/1
 07/03/2024

DMOB-SS



 Kit di sospensione attrezzatura per DMOB2 ad 1 o 2 bracci per altrettante levigatrici orbitali.

 Suspension kit for DMOB2 with 1 or 2 arms for hanging the relevant orbital sanders.

 Kit de suspension pour DMOB2 avec 1 ou 2 bras pour ponceuses orbitales.

 Aufhängungssatz für DMOB2 mit 1 oder 2 Armen für mehrere Schleifmaschinen.

 Kit de suspensión para DMOB2 con 1 o 2 brazos para varias lijadoras orbitales.

DMOB2SS	nr. supp.
DMOB2SS	1
DMOB2SS2	2

DM29-PN



 Manichetta flessibile diam 29 mm con tubazione di alimentazione pneumatica integrata.

 Flexible hose 29 mm with integrated pneumatic supply.

 Flexible de 29 mm avec tuyau d'alimentation pneumatique intégré.

 Flexibler Schlauch 29 mm mit integrierter pneumatischer Versorgungsleitung.

 Manguera flexible de 29 mm con tubo de suministro neumático integrado.

DM29	Ø	L.	Pneum.	Electr.
DM295PN	29 mm	5 m	√	-
DM298PN	29 mm	8 m	√	-
DM2910PN	29 mm	10 m	√	-

DM29-EL



 Manichetta flessibile diam 29 mm per collegamento a levigatrici elettriche (cavo elettrico escluso).

 Flexible hose diam 29 mm for connecting electric orbital sanding machines (electric feeding cable excluded).

 Tuyau flexible diam 29 mm pour raccorder des ponceuses électriques orbitales (câble d'alimentation électrique exclu).

 Flexibler Schlauch Ø 29 mm zum Anschluss von elektrischen Schleifmaschinen (ausgenommen Elektrokabel).

 Manguera flexible de 29 mm de diámetro para conectar lijadoras orbitales eléctricas (cable de alimentación eléctrica excluido).

DM29	Ø	L.	Pneum.	Electr.
DM295EL	29 mm	5 m	-	√
DM298EL	29 mm	8 m	-	√

DMOB2-5S

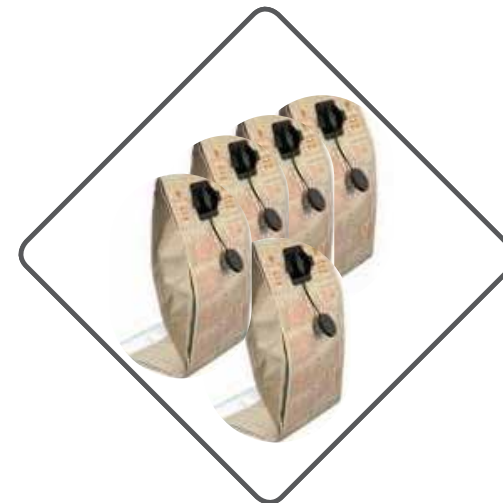

 Set di 5 sacchetti filtranti di ricambio per DMOB2.

 Set of 5 replacement filter bags for DMOB2.

 Lot de 5 sacs filtrants de remplacement pour DMOB2.

 Set mit 5 Ersatzbeutelfilter für DMOB2.

 Kit de 5 bolsas filtrante de repuesto para DMOB2.

DMOB2-5S	NR.	Cont.
DMOB2-5S	5 PZ	7,1 Kg

DT2M



 Turbina carrellata da 2hp per impieghi gravosi e prolungati nel tempo. DTD2M è una soluzione mobile per lavori pesanti che un normale aspirapolvere non può reggere, dotato di soffiante a canali laterali, pulizia automatica del filtro e partenza automatica all'utensile.

 2hp wheeled turbine for heavy-duty and prolonged use. DTD2M is a mobile solution for heavy-duty jobs that a normal vacuum cleaner cannot handle, equipped with a side channel blower, automatic filter cleaning and automatic start-up at the tool.

 Turbina mobile de 2 CV pour une utilisation intensive et prolongée. Le DTD2M est une solution mobile pour les travaux lourds qu'un aspirateur normal ne peut pas supporter, équipé d'un ventilateur à canaux latéraux, d'un nettoyage automatique du filtre et d'un démarrage automatique à l'outil.

 2-PS-Turbine auf Rädern für schwere und lang andauernde Einsätze. DTD2M ist eine mobile Lösung für schwere Arbeiten, die ein normaler Staubsauger nicht bewältigen kann, ausgestattet mit einem Seitenkanalgebläse, automatischer Filterreinigung und automatischem Start am Werkzeug.

 Turbina con carro de 2 CV para usos intensivos y prolongados. DTD2M es una solución móvil para trabajos pesados que una aspiradora normal no puede soportar, equipada con soplador de canales laterales, limpieza automática del filtro y arranque automático desde la herramienta.

DT2M	Kw	V	Hz	m3/h	mm H ₂ O	m ²	dB	Auto start
DT2M	1,5	230	50/60	240	2200	1	65	Electr. - Pneum.



via Masaccio, 15
42124 Reggio Emilia (RE) ITALY
Tel. +39 0522 1545193
vendite@worky-italy.com
sales@worky-italy.com

www.worky-italy.com

DT2M - technical datasheet

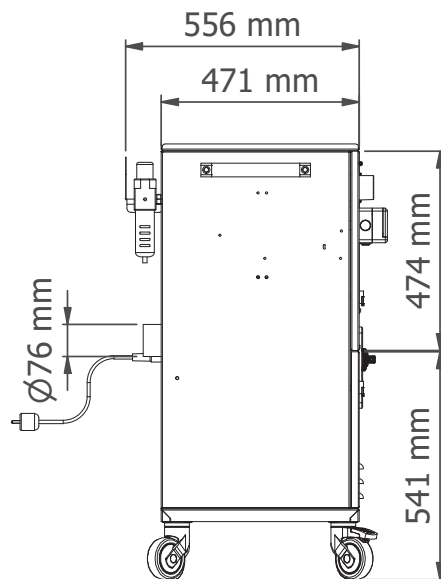
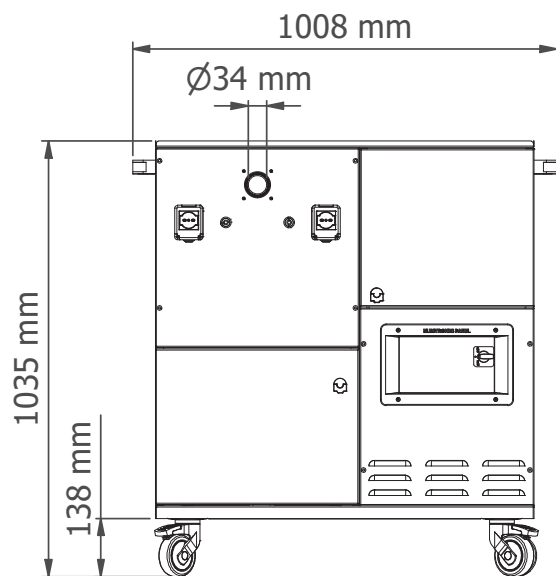

PTFE FILTER	
FILTERING SURFACE	1 m ²
CONTAINER CAPACITY	20 L
EFFICIENCY	99,5%
AUTOMATIC FILTER CLEANING	✓

PERFORMANCE	
POWER	1,5 Kw / 2 HP
	230 V - 1 ph
	50/60 Hz
MOTOR MAX ABSORPTION	9 A
Db	65
MAX AIR FLOW RATE	240 m ³ /h
MAX VACUUM LEVEL	2200 mmH ₂ O
AUTOMATIC START	✓



COD	El. conn.	Air. conn.	PACK			Kg Tot
			l [mm]	w [mm]	h [mm]	
DT2M	2 x 230V	2 x 3/8"	1030	670	1550	130

THIS DRAWING IS PROPERTY OF DEA + RO & Co S.p.A. THE COMPLETE OR PARTIAL REPRODUCTION OF THIS DOCUMENT IS FORBIDDEN. THE OWNER RESERVES THE RIGHT TO UPDATE, MODIFY OR AMEND ANY SPECIFICATION WITHOUT PRIOR NOTICE.

Rev.00

1/1
03/05/2024



CAT. ACCESS.

CAT. VENTILAT.

CAT. NOZZLES



SCAN THE QR CODE
DOWNLOAD THE
CATALOGUE



SCAN THE QR CODE
DOWNLOAD THE
CATALOGUE



SCAN THE QR CODE
DOWNLOAD THE
CATALOGUE



WORRY®

WORKY®

WORKY Headquarters and Production

Via Masaccio, 15 - Z.I. Mancasale
42124 - REGGIO EMILIA (RE) ITALY

Tel. **+39-0522-1545193**

Fax. **+39-0522-1546451**

sales@worky-italy.com

vendite@worky-italy.com

www.worky-italy.com

WORKY North America Inc.

112 South Tryon Street
Suite 1130 Charlotte, North Carolina
28284 USA

Tel **+1 (305) 705 5017**

www.deaworkyna.com



Inquadra il QR Code e scopri il nostro sito!
Frame the QR Code to discover our website!



Seguici su / Follow us on:



QUALITY CERTIFIED ISO 9001:2015