



# WORKY®

PANNELLI

PANELS

PANNEAUX

WANDPANELEE

PANELES MURALES

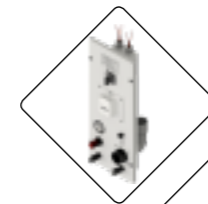

**DTD1**  
Pag. 6

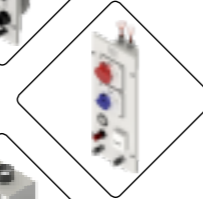

**DTD1EN**  
Pag. 8

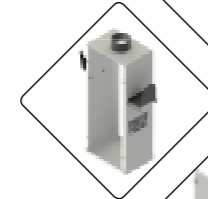

**DTD1C**  
Pag. 10



**DTD2**  
Pag. 12

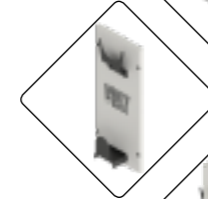

**DTDH**  
Pag. 14

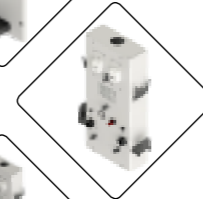

**DCC2**  
Pag. 18

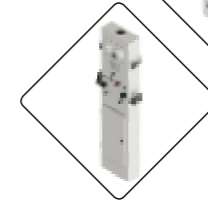



**DCL2**  
Pag. 20





# DTD

 I pannelli DTD, sia in versione singola che doppia, permettono una distribuzione dell'energia elettrica e dell'aria compressa congiuntamente all'aspirazione delle polveri di carteggiatura. La particolarità è che questi pannelli possono essere incastrati tagliando la parete di fondo della zona di preparazione e rimanere a filo con essa senza sporgere.

 DTD panels, in both single and double versions, allow for the distribution of electrical power and compressed air in conjunction with the extraction of dry sanding dust. The special feature is that these panels can be fitted by cutting into the back wall of the preparation bay and remain flush with it without protruding.

 Les panneaux DTD, en version simple ou double, permettent la distribution de l'énergie électrique et de l'air comprimé ainsi que l'aspiration des poussières de ponçage. La particularité de ces panneaux est qu'ils peuvent être montés en découpant la paroi arrière de la zone de préparation et qu'ils restent à fleur de celle-ci sans faire saillie.

 DTD-Paneele, sowohl in einfacher als auch in doppelter Ausführung, ermöglichen die Verteilung von Strom und Druckluft in Verbindung mit der Absaugung von Schleifstaub. Die Besonderheit ist, dass diese Platten durch Einschneiden in die Rückwand des Vorbereitungsraumes montiert werden können und bündig mit ihr abschließen, ohne vorzustehen.

 Los paneles DTD, tanto en versión simple como doble, permiten distribuir la energía eléctrica y el aire comprimido junto con la aspiración del polvo de lijado. La particularidad de estos paneles es que pueden instalarse cortando la pared posterior de la zona de preparación y quedan enrasados con ella sin sobresalir.







# DTD1

 Pannello monoservizi da incasso, equipaggiato con una presa per aspirazione polveri, utenze elettriche e pneumatiche.

 Single service panel to be integrated in preparation area wall, equipped with one inlet for dust extraction, electrical and pneumatic services.

 Panneau de distribution d'énergies mono-service à intégrer dans une paroi technique équipé avec 1 prise pour l'aspiration, 1 prise électrique, raccords d'air comprimé.

 Multifunktion-Wandbedienungspaneel, ausgestattet mit pneumatischen und elektrischen Anschlüsse und Absauggstrichter.

 Panel de servicio multifunción para integrar en la pared con disponibilidad de conexiones eléctricas y neumáticas, así como de toma de extracción.

DTD1	Extr.	Pneum.	Electr.	Aut	Cut
DTD1	1 x 29 mm	2 x 3/8"	1 x 230V	-	-
DTD1-UK	1 x 29 mm	2 x 3/8"	1 x 230V	-	-
DTD1A	1 x 29 mm	2 x 3/8"	1 x 230V	✓	-
DTD1A-UK	1 x 29 mm	2 x 3/8"	1 x 230V	✓	-
DTD1AC	1 x 29 mm	2 x 3/8"	1 x 230V	✓	✓
DTD1AC-UK	1 x 29 mm	2 x 3/8"	1 x 230V	✓	✓



**WORXY**  
www.worxy-italy.com

via Masaccio, 15  
42124 Reggio Emilia (RE) ITALY  
Tel. +39 0522 1545153  
vendite@worxy-italy.com  
sales@worxy-italy.com

DTD1 - technical datasheet

COD	El. conn.	Air. conn.	Aut	Cut	PACK			Kg Tot
					l [mm]	w [mm]	h [mm]	
DTD1	1 x 230V	2 x 1/8"	X	X	600	550	300	9
DTD1A	1 x 230V	2 x 1/8"	✓	X	600	550	300	9



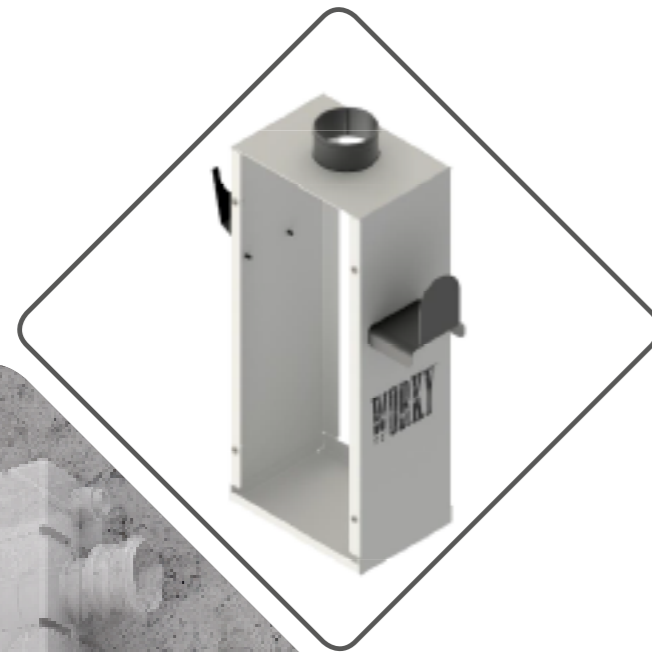
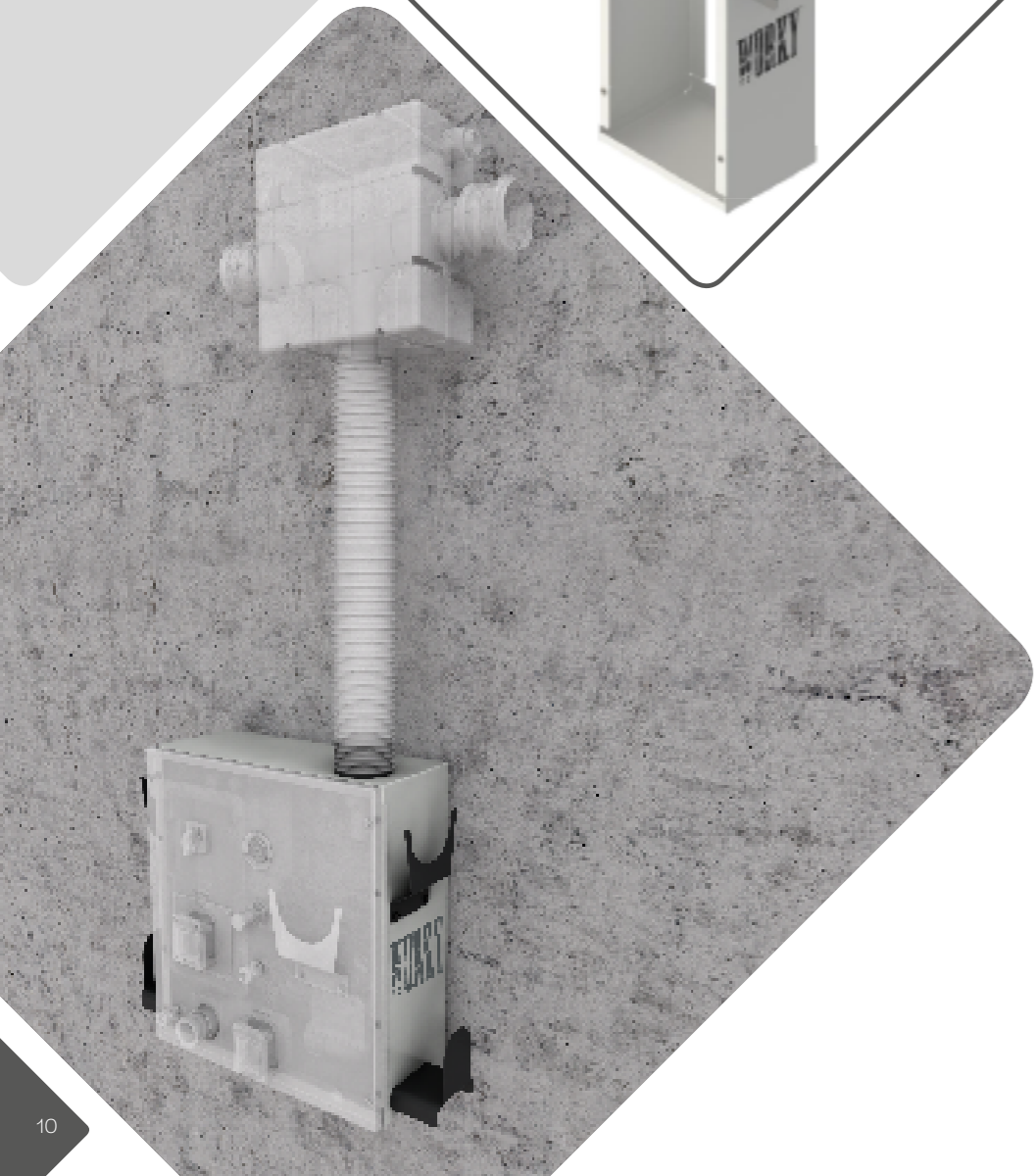

THE DRAWING IS PROPERTY OF WIP s.p.a. & CO.S.P.A. THE COMPETITION IN THE MANUFACTURE OF THE EQUIPMENT IS ADMITTED. THE USER ASSUMES THE RISK OF WEIGHT, WEIGHT VARIATIONS AND DIMENSIONS WITHOUT FURTHER NOTICE.

Rev.00
1/1  
15/03/2024







# DTD1C

-  Carter predisposto per il fissaggio dei DTD1 su pareti di cemento in cui non è possibile l'incasso.
-  Carter suitable for fixing DTD1 on concrete walls where recessed installation is not possible.
-  Carter pour la fixation du panneau DTD1 sur des murs en béton où une installation encastrée n'est pas possible.
-  Gehäuse für die Befestigung von DTD1 an Betonwänden geeignet, bei denen eine integrierte Installation nicht möglich ist.
-  Módulo adecuado para la fijación de DTD1 en paredes de hormigón donde la instalación empotrada no es posible.

**WORKY**  
 via Masaccio, 15  
 42124 Reggio Emilia (RE) ITALY  
 Tel. +39 0522 1545153  
 vendite@worky-italy.com  
 sales@worky-italy.com  
 www.worky-italy.com

DTD1C - technical datasheet





CCD	PACK			Kg Tot
	l [mm]	w [mm]	h [mm]	
DTD1C	200	450	250	4



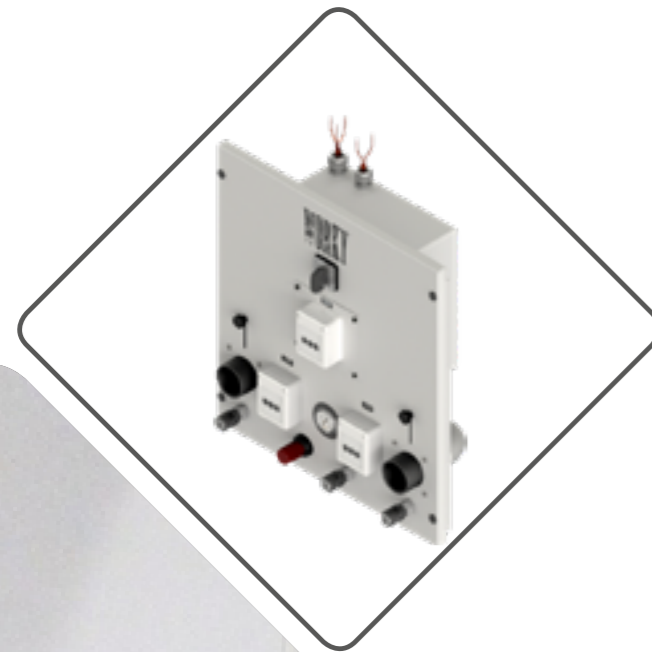

THE COMPANY IS PROPERTY OF BPA + IO S.p.A., THE COMPANY HAS THE RIGHT TO MODIFY, WITHOUT NOTICE, THE SPECIFICATIONS OF THE PRODUCT.

Rev.00

1/1  
02/05/2024



# DTD2

-  Pannello doppio da incasso, equipaggiato con due prese per aspirazione polveri, utenze elettriche e pneumatiche.
-  Single service panel to be integrated in preparation area wall, equipped with two inlets for dust extraction, electrical and pneumatic services.
-  Panneau de distribution d'énergies mono-service à intégrer dans une paroi technique équipé avec 2 prises pour l'aspiration, 3 prise électriques et 3 raccords d'air comprimé.
-  Multifunktion-Wandbedienungspaneel, ausgestattet mit pneumatischen und elektrischen Anschlüsse, und Absaugugstrichern.
-  Panel de servicio multifunción para integrar en la pared con disponibilidad de conexiones eléctricas y neumáticas, así como de toma de extracción.

DTD2	Extr.	Pneum.	Electr.	Aut	Cut
DTD2	2 x 29 mm	3 x 3/8"	3 x 230V	-	-
DTD2-UK	2 x 29 mm	3 x 3/8"	3 x 230V	-	-
DTD2A	2 x 29 mm	3 x 3/8"	3 x 230V	✓	-
DTD2A-UK	2 x 29 mm	3 x 3/8"	3 x 230V	✓	-
DTD2AC	2 x 29 mm	3 x 3/8"	3 x 230V	✓	✓
DTD2AC-UK	2 x 29 mm	3 x 3/8"	3 x 230V	✓	✓

**WORXY**  
www.worxy-italy.com

via Masaccio, 15  
42124 Reggio Emilia (RE) ITALY  
Tel. +39 0522 1545153  
vendite@worxy-italy.com  
sales@worxy-italy.com

DTD2 - technical datasheet

Dimensions: 180 mm (width), 520 mm (height), 142 mm (depth), 20 mm (depth), 460 mm (width), 263 mm (width), 420 mm (height), 210 mm (depth), 55 mm (depth), Ø34 mm (hole diameter), Ø50 mm (hole diameter), 490 mm (width).

Code	Electr. conn.	Air conn.	Aut	Cut	l [mm]	PACK w [mm]	h [mm]	kg lot
DTD2	3 x 230V	3 x 3/8"	X	X	630	550	300	12
DTD2A	3 x 230V	3 x 3/8"	✓	X	630	550	300	12
DTD2AC	3 x 230V	3 x 3/8"	✓	✓	630	550	300	12





The drawings are property of WORXY and its GROUP. The copyright and the manufacturing right are reserved to WORXY. The vendor assumes the liability for errors, omissions and any modifications without prior notice.

Rev.00

1/1  
15/03/2024



# DTDH

-  Pannello con mensole per il sostegno della levigatrice e della relativa tubazione a riposo.
-  Wall panel with supports for the sanding machine and the relevant extraction hose.
-  Panneau avec étagères pour supporter la ponceuse et son flexible d'aspiration des poussières.
-  Paneel mit Halterungen für die Schleifmaschine und ihrer Absaugschlauch.
-  Panel con estantes para soportar la lijadora y su tubo de aspiración.

**WORXY**  
www.worxy-italy.com

via Masaccio, 15  
42124 Reggio Emilia (RE) ITALY  
Tel. +39 0522 1545193  
vendite@worxy-italy.com  
sales@worxy-italy.com

DTDH - technical datasheet

COD	PACK			Kg Tot
	l [mm]	w [mm]	h [mm]	
DTDH	550	300	150	3

Tutti i diritti sono riservati. È vietata espressamente la ristampa o l'uso non autorizzato senza permesso scritto dalla Worxy Italia S.p.A.

Rev.00

1/1  
30/04/2012

# DC

 Le colonne e i pannelli murali DC sono pensati per fornire utenze elettriche e pneumatiche, unitamente all'aspirazione delle polveri su pareti in cui non sia possibile fare l'incasso. Queste strutture sono dotate di supporto degli utensili e delle manichette di aspirazione.

 DC columns and wall panels are designed to provide electrical and pneumatic utilities, together with dust extraction on walls where it is not possible to recess such provisions. These structures are equipped with tool holders and suction hoses.

 Les bornes et les panneaux muraux DC sont conçus pour fournir des données électriques et pneumatiques, ainsi qu'une extraction de la poussière de ponçage sur les murs où il n'est pas possible de faire des encastements. Ces structures sont équipées de porte-outils et flexibles d'aspiration.

 Die DC-Säulen und Wandpaneele sind für die elektrische und pneumatische Versorgung sowie für die Staubabsaugung an Wänden, die nicht versenkt werden können, konzipiert sind. Diese Strukturen sind mit Werkzeughaltern und Absaugschläuchen ausgestattet.

 Las columnas y los paneles murales DC están diseñados para proporcionar servicios eléctricos y neumáticos, además de extracción de polvo de lijado en paredes donde no es posible empotrar. Estas estructuras están equipadas con portaherramientas y soportes para mangueras de aspiración.







# DCC2











 Pannello doppio da parete, equipaggiato con due prese per aspirazione polveri, utenze elettriche, pneumatiche e supporto utensili integrato.

 Single service panel to be wall mounted, equipped with two inlets for dust extraction, electrical and pneumatic services as well as supports for tools and hoses.

 Panneau de distribution d'énergies mono-service à installer au mur équipé avec 2 prises pour l'aspiration, 2 prises électriques, 3 raccords d'air comprimé et supports pour les utillages d'aspiration.

 Multifunktion-Bedienungspaneel für Wandmontage. Geeignet für 2 Absaugeinheiten, 2 Stechkodosen, 3 Druckluftanschlüssen und Halterungen für Schleifmaschinen und Schläuchen.

 Panel de servicio multifunción para instalación a pared con 2 tomas de aspiración, 2 enchufes electricos, 3 tomas rapidas de aire comprimido y soportes para lijadoras y mangueras.

DCC2	Extr.	Pneum.	Electr.	Aut	Cut
DCC2A	2 x 29 mm	3 x 3/8"	2 x 230V  	✓	-
DCC2A-2UK	2 x 29 mm	3 x 3/8"	2 x 230V  	✓	-
DCC2A-WS	2 x 29 mm	3 x 3/8"	0 x 230V - -	✓	-
DCC2AC	2 x 29 mm	3 x 3/8"	2 x 230V  	✓	✓
DCC2AC-2UK	2 x 29 mm	3 x 3/8"	2 x 230V  	✓	✓
DCC2AC-400230	2 x 29 mm	3 x 3/8"	1x230V 1x400V  	✓	✓

**WORXY**  
 via Masaccio, 15  
 42124 Reggio Emilia (RE) ITALY  
 Tel. +39 0522 1545193  
 vendite@worxy-italy.com  
 sales@worxy-italy.com  
 www.worxy-italy.com

## DCC2 - technical datasheet

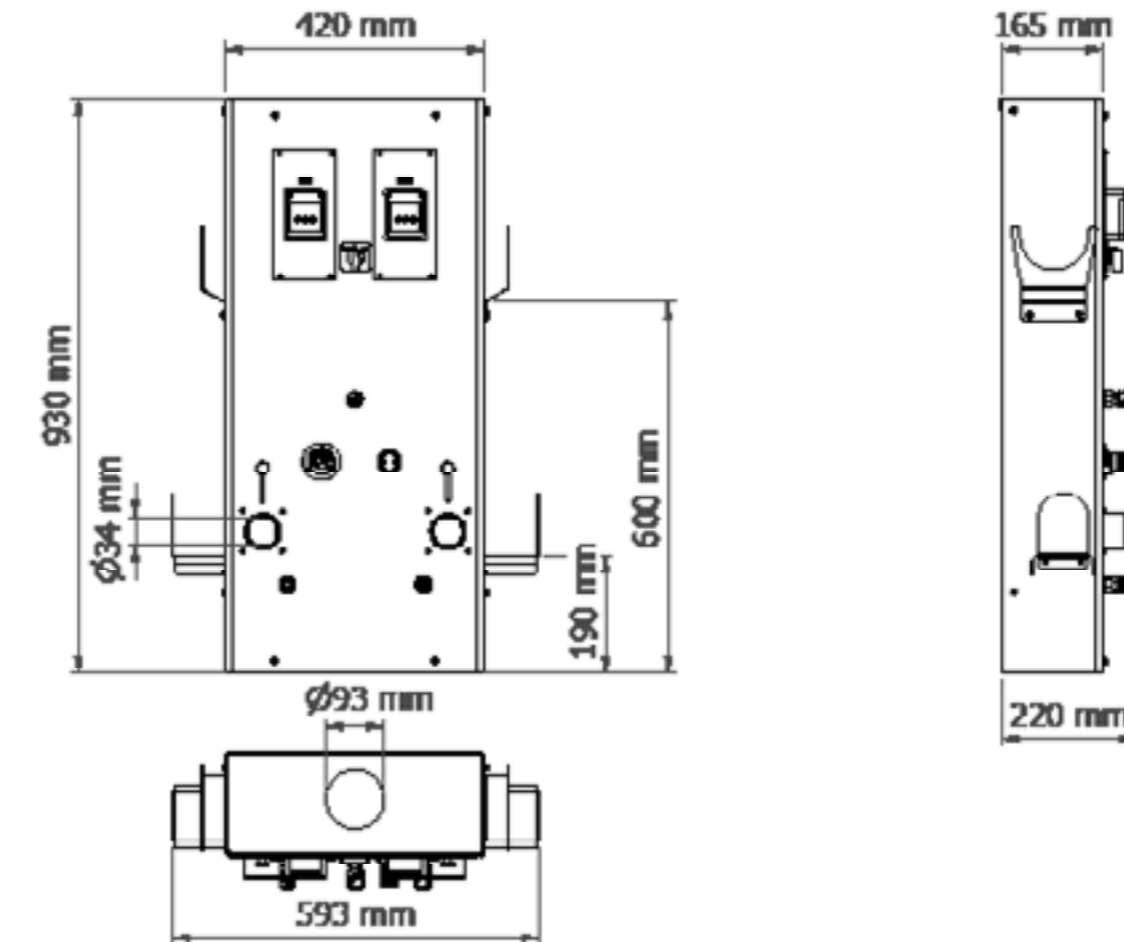

COD	El. conn.	Air. conn.	Aut	Cut	PACK			Kg Tot
					l [mm]	w [mm]	h [mm]	
IND2A	2 x 230V	3 x 3/8"	✓	✓	930	450	100	??
IND2AC	2 x 230V	3 x 3/8"	✓	✓	930	450	100	??















Rev.00

1/1  
22/03/2024



# DCL2

-  Colonna da parete, equipaggiata con due prese per aspirazione polveri, utenze elettriche, pneumatiche, supporto utensili integrato e armadietto porta attrezzatura.
-  Service tower equipped with two inlets for dust extraction, electrical and pneumatic services, supports for tools and hoses as well as lower closet for small equipment.
-  Borne de distribution d'énergies équipé avec 2 prises pour l'aspiration, 2 prises électriques, 3 raccords d'air comprimé, supports pour les outillages d'aspiration et rangement pour petit équipement.
-  Multifunktion-Bedienungssäule geeignet für 2 Absaugeinheiten, 2 Stechkodosen, 3 Druckluftanschlüssen, Halterungen für Schleifmaschinen und Schläuchen so wie einen Schrank.
-  Column de servicio multifunción con 2 tomas de aspiración, 2 enchufes electricos, 3 tomas rapidas de aire comprimido, soportes para lijadoras y mangueras y armario para herramientas.

DCL2	Extr.	Pneum.	Electr.	Aut	Cut
DCL2A	2 x 29 mm	3 x 3/8"	2 x 230V	 	✓ -
DCL2A-2UK	2 x 29 mm	3 x 3/8"	2 x 230V	 	✓ -
DCL2A-WS	2 x 29 mm	3 x 3/8"	0 x 230V	- -	✓ -
DCL2AC	2 x 29 mm	3 x 3/8"	2 x 230V	 	✓ ✓
DCL2AC-2UK	2 x 29 mm	3 x 3/8"	2 x 230V	 	✓ ✓

**WORKY**  
www.worky-italy.com

via Masaccio, 15  
42124 Reggio Emilia (RE) ITALY  
Tel. +39 0522 1545153  
vendite@worky-italy.com  
sales@worky-italy.com

**DCL2 - technical datasheet**

CLIP	EL. conn.	Air. conn.	AUT	CUT	PACK			kg tot
	l [mm]	w [mm]	h [mm]					
DCL2A	2 x 230V	3 x 3/8"	✓	X	1550	450	300	38
DCL2AC	2 x 230V	3 x 3/8"	✓	✓	1550	450	300	38

Rev.00

1/1  
21/03/2024



# CAT. ACCESS. CAT. VENTILAT. CAT. NOZZLES



SCAN THE QR CODE  
DOWNLOAD THE  
CATALOGUE



SCAN THE QR CODE  
DOWNLOAD THE  
CATALOGUE



SCAN THE QR CODE  
DOWNLOAD THE  
CATALOGUE



# WORKY®



# WORKY®

## WORKY Headquarters and Production

Via Masaccio, 15 - Z.I. Mancasale  
42124 - REGGIO EMILIA (RE) ITALY

Tel. +39-0522-1545193

Fax. +39-0522-1546451

[sales@worky-italy.com](mailto:sales@worky-italy.com)

[vendite@worky-italy.com](mailto:vendite@worky-italy.com)

[www.worky-italy.com](http://www.worky-italy.com)

## WORKY North America Inc.

112 South Tryon Street  
Suite 1130 Charlotte, North Carolina  
28284 USA

Tel +1 (305) 705 5017

[www.deaworkyna.com](http://www.deaworkyna.com)



**Inquadra il QR Code e scopri il nostro sito!**  
**Frame the QR Code to discover our website!**



**Seguici su / Follow us on:**



QUALITY CERTIFIED ISO 9001:2015