



WORKY[®]

MINISET



GMS1

Pag. 6



GMS2

Pag. 8



GMS-AU

Pag. 10



GMS-AU-FAP

Pag. 12



GMS-AU200

Pag. 14



GMSZ

Pag. 16

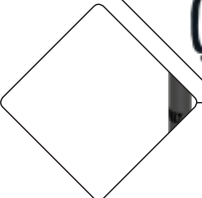



GTD

Pag. 18





MINISET

 Il MINISET rappresenta il kit da impianto più semplice in gamma. Aspiratore, tubo e bocchetta sono l'essenziale per aspirare i gas di scarico, ma anche in un sistema semplice si celano versioni dedicate ad applicazioni molto specifiche come la rigenerazione del filtro anti particolato o per la prova opacimetrica. La gamma si completa con soluzione per fumi ad alta temperatura e bocchette in acciaio anche montate su carrello per facilitarne la movimentazione.

 The MINISET is the simplest kit in our range. Fan, hose, and nozzle are the “essentials” to extract exhaust gases, nevertheless, even for such a simple system you can find several versions designed for very specific procedures, as DPF cleaning or emission testing. The product line includes high temperature solutions and steel nozzles on a mobile stand for an easy handling.

 Le MINISET est le kit d'installation le plus facile dans la gamme. L'aspirateur, le tuyau et l'entonnoir sont essentiels pour aspirer les gaz d'échappement, mais aussi dans un système simple il y a des versions dédiées à des applications très spécifiques telles que la régénération du filtre à particules ou pour le tests d'opacimétrie. La gamme est complétée par des solutions pour les gaz à haute température avec entonnoirs en acier aussi installé sur chariot pour manutention facile.





 Das MINISET ist das einfachste Anlage der Produktpalette. Die Ventilatoren, Schläuche und Trichter sind die Grundlage, um Abgase abzuleiten aber auch in so einem einfachen System können Versionen entwickelt werden, die für sehr spezifischen Anwendungen wie die Regeneration des Partikelfilters oder den Abgasuntersuchung vorgesehen sind. Der Sortiment wird mit einer Lösung mit Hochtemperatureschlauch und Stahltrichter mit Wagen vervollständigt, deren Bewegung leichter machen.

 El MINISET representa el kit más sencillo de la gama. Extractor, manguera y boquerel son el esencial para extraer los gases de escape, pero al mismo tiempo detrás de un sistema que aparece tan sencillo, hay versiones especiales para aplicaciones específicas, como la regeneración de los filtros de antipartículas o para la prueba opacimétrica. La gama se completa con soluciones para gases de alta temperatura y boquereles en acero también con carro, para facilitar su movimentación.





GMS1

-  Miniset con aspiratore da 0,5 HP - 400V trifase 50Hz, tubo flessibile, mensola murale e bocchetta in gomma GRN.
-  Miniset with 0,5HP 400V 3PH 50HZ fan, hose, wall bracket and GRN rubber nozzle.
-  Miniset avec aspirateur de 0,5 HP - 400 V triphasée 50Hz, tuyau flexible, console murale et entonnoir en caoutchouc GRN.
-  Miniset mit 0,37 kw Ventilator 400V 3PH 50HZ, Schlauch, Wandkonsole und GRN Gummitrichter.
-  Miniset completo de aspirador 0,5 HP - 400V trifasico 50Hz, manguera, soporte a pared y boquerel en goma GRN.

GMS1	HP	Ø	L.	Spec.
GMS1755	0,5	75 mm	5 m	GRN
GMS1755-K	0,5	75 mm	5 m	GRNK
GMS1757	0,5	75 mm	7,5 m	GRN
GMS1757-SB	0,5	75 mm	7,5 m	-
GMS17510	0,5	75 mm	10 m	GRN
GMS11005	0,5	100 mm	5 m	GRN
GMS11007	0,5	100 mm	7,5 m	GRN
GMS110010	0,5	100 mm	10 m	GRN



via Masaccio, 15
42124 Reggio Emilia (RE) ITALY
Tel. +39 0522 1545193
vendite@worky-italy.com
sales@worky-italy.com

www.worky-italy.com

GMS1 - technical datasheet

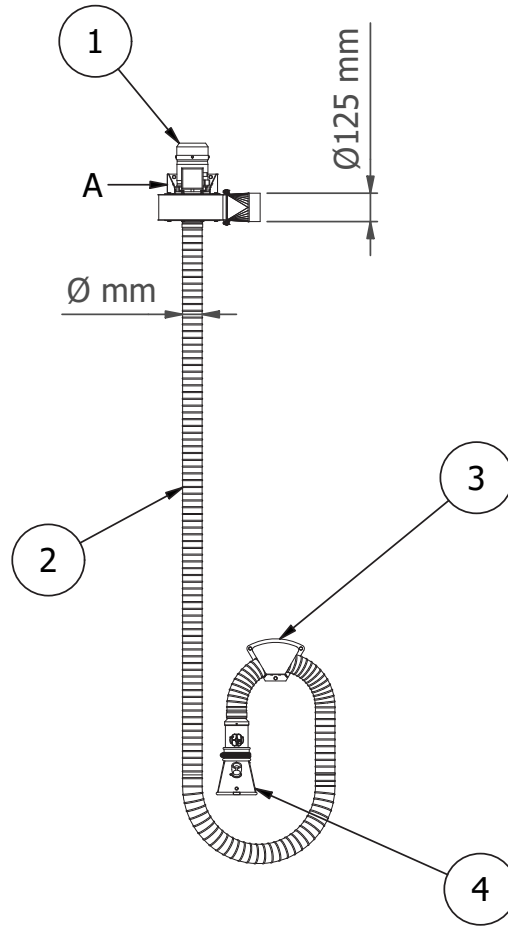
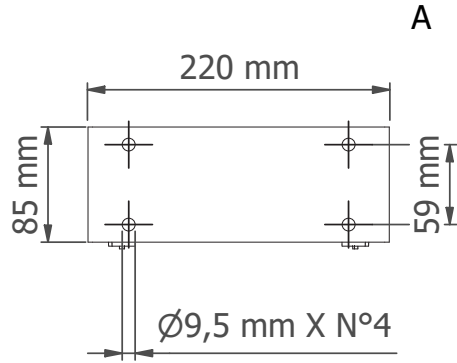

COD	Part 1	Kw/HP	Part 2 Ø [mm]	Part 2 L [m]	Part 3	Part 4	PACK			Kg
							l [mm]	w [mm]	h [mm]	
GMS1755	GSA0.5	0.37/0.5	75	5	GWB-100	GRN	600	400	800	23.5
GMS1755-K	GSA0.5	0.37/0.5	75	5	GWB-100	GRNK	600	400	800	23.5
GMS1757	GSA0.5	0.37/0.5	75	7.5	GWB-100	GRN	600	400	800	26
GMS17510	GSA0.5	0.37/0.5	75	10	GWB-100	GRN	600	600	970	28
GMS11005	GSA0.5	0.37/0.5	100	5	GWB-100	GRN	600	600	970	24
GMS11007	GSA0.5	0.37/0.5	100	7.5	GWB-100	GRN	600	600	970	27
GMS110010	GSA0.5	0.37/0.5	100	10	GWB-100	GRN	600	600	970	30

THIS DRAWING IS PROPERTY OF DEA + RO & Co S.p.A. THE COMPLETE OR PARTIAL REPRODUCTION OF THIS DOCUMENT IS FORBIDDEN. THE OWNER RESERVES THE RIGHT TO UPDATE, MODIFY OR AMEND ANY SPECIFICATION WITHOUT PRIOR NOTICE.

Rev.00

1/1
19/11/2024

GMS2

 Miniset con doppio tubo flessibile, aspiratore, doppia mensola murale e bocchette in gomma GRN.

 Double Miniset with fan, two hoses, wall brackets and GRN rubber nozzles.

 Miniset avec aspirateur, deux tuyaux flexibles, deux consoles murale et deux entonnoirs en caoutchouc GRN.

 Doppelminiset mit Ventilator, zwei Schläuche, Wandkonsole und GRN Gummitrichter.

 Miniset completo de aspirador, dos mangueras, soportes a pared y boquereles en goma GRN.

GMS1	HP	Ø	L.	Spec.
GMS2755	0,5	2 x 75 mm	5 m	GRN
GMS2757	0,5	2 x 75 mm	7,5 m	GRN
GMS27510	0,5	2 x 75 mm	10 m	GRN
GMS21005WN	1	2 x 100 mm	5 m	-
GMS21005	1	2 x 100 mm	5 m	GRN
GMS21007	1	2 x 100 mm	7,5 m	GRN
GMS210010	1	2 x 100 mm	10 m	GRN





via Masaccio, 15
42124 Reggio Emilia (RE) ITALY
Tel. +39 0522 1545193
vendite@worky-italy.com
sales@worky-italy.com

www.worky-italy.com

GMS2 - technical datasheet

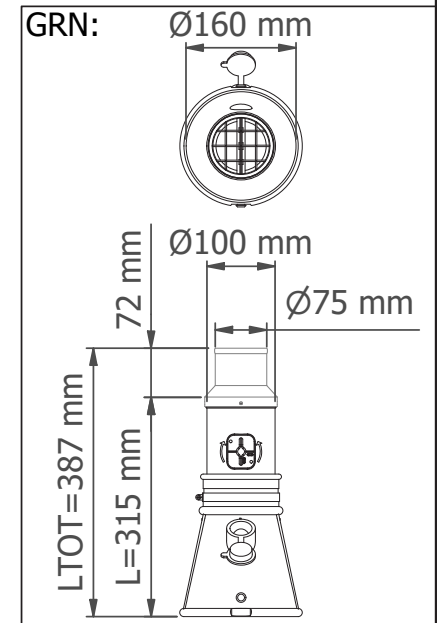
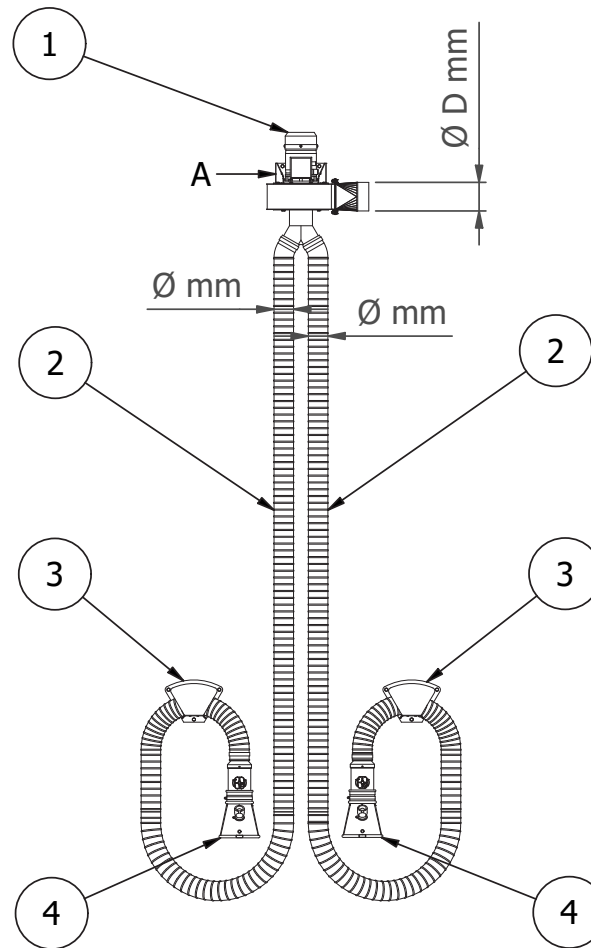
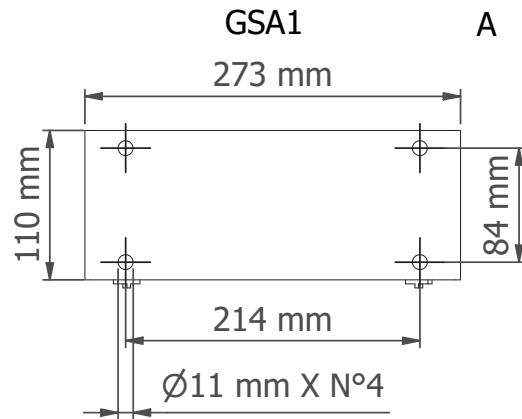
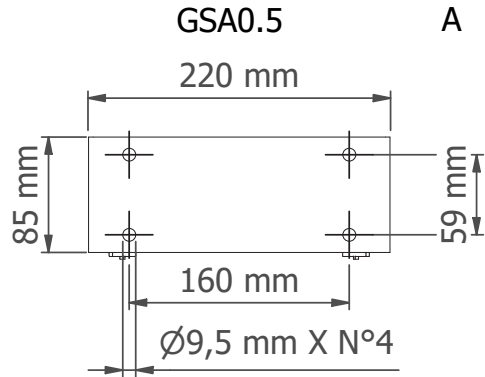

COD	Part 1	Kw/HP	Ø D [mm]	Part 2 Ø [mm]	Part 2 L [m]	Part 3	Part 4	PACK			Kg
								l [mm]	w [mm]	h [mm]	
GMS2755	GSA0.5	0.37/0.5	125	2 X 75	2 X 5	2 X GWB-100	2 X GRN	600	600	950	29
GMS2757	GSA0.5	0.37/0.5	125	2 X 75	2 X 7.5	2 X GWB-100	2 X GRN	600	800	1000	34
GMS27510	GSA0.5	0.37/0.5	125	2 X 75	2 X 10	2 X GWB-100	2 X GRN	600	800	1000	38
GMS21005	GSA1	0.75/1	160	2 X 100	2 X 5	2 X GWB-100	2 X GRN	600	800	1000	37
GMS21007	GSA1	0.75/1	160	2 X 100	2 X 7.5	2 X GWB-100	2 X GRN	600	800	1150	42
GMS210010	GSA1	0.75/1	160	2 X 100	2 X 10	2 X GWB-100	2 X GRN	600	800	1150	48

THIS DRAWING IS PROPERTY OF DEA + RO & Co S.p.A. THE COMPLETE OR PARTIAL REPRODUCTION OF THIS DOCUMENT IS FORBIDDEN. THE OWNER RESERVES THE RIGHT TO UPDATE, MODIFY OR AMEND ANY SPECIFICATION WITHOUT PRIOR NOTICE.

Rev.00

1/1
19/11/2024

GMS-AU

-  Miniset singolo con bocchetta carrellata certificata TUV per aspirare i gas di scarico prodotti durante la prova opacimetrica.
-  Single miniset with TUV approved nozzle on trolley, to extract gases during emission testing.
-  Miniset individuel avec entonnoir sur charriot certifié TUV pour l'aspiration de gaz d'échappement produit pendant les tests d'opacimétrie
-  Einzelminisatz komplett mit von TUV freigegebenem Trichter mit Wagen, geeignet für AU-Abgasabsaugung.
-  Miniset síngulo con boquerel con carrito certificado TUV para la extracción de los gases durante la prueba opacimétrica.

GMS-AU	HP	Ø	L.	Temp.	Spec.
GMSAU-100	1,0	100 mm	5 m	200°C	GRNP-100HT
GMSAU-150	1,5	150 mm	7,5 m	200°C	GRNP-150HT



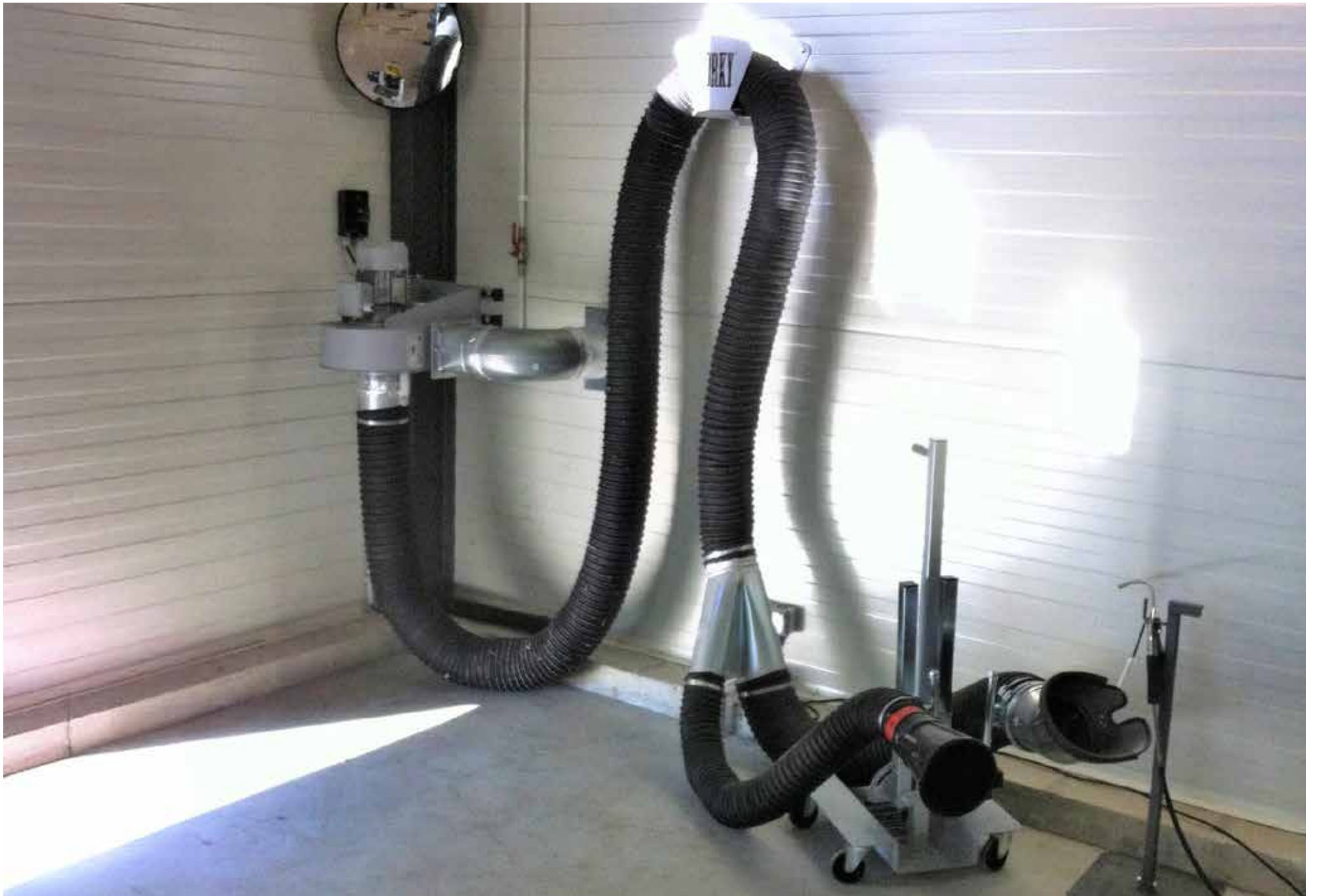



GMS-AU-FAP



 Miniset singolo con bocchetta carrellata certificata TUV per aspirare i gas di scarico in condizioni di alta temperatura (rigenerazione del filtro anti particolato).

 Single miniset with TUV approved nozzle on trolley, to extract gases during high-temperature procedures (DPF cleaning).

 Miniset individuel avec entonnoir sur charriot certifié TUV pour l'aspiration de gaz d'échappement en conditions de hautes températures (régénération du filtre à particules).

 Einzelminisatz komplett mit von TUV freigegebenem Trichter mit Wagen, Hochtemperatureschlauch, geeignet für die Abgasabsaugung in Sonderkonditionen (Z.B. DPF-Regenerierung)

 Miniset único con boquerel con carrito certificado TUV para la extracción de los gases en condiciones de alta temperatura (regeneración del filtro DPF)

GMS-AU-FAP	HP	Ø	L.	Temp.	Spec.
GMS-AU150T5	1,5	150 mm	5 m	500°C	GRNP-150HT
GMS-AU150T7	1,5	150 mm	5 m	700°C	GRNP-150HT
GMS-AU150-GYHT5	1,5	150 mm	5 m	500°C	GYNMA-HT
GMS-AU150T5SB	1,5	150 mm	5 m	500°C	-





GMS-AU200



 Miniset singolo ad alte prestazioni con bocchetta carrellata di grandi dimensioni per aspirare i gas di scarico in condizioni gravose e con alte temperature.

 Single miniset with big mobile nozzle to extract gases during high-temperature, heavy-duty procedures.

 Miniset individuel à hautes performances avec entonnoir de grandes dimensions sur charriot pour l'aspiration de gaz d'échappement à hautes températures.

 Einzelminisatz komplett mit Trichter mit Wagen, Hochtemperatureschlauch, geeignet für die Abgasabsaugung in Sonderkonditionen.





 Miniset único con boquerel con carrito para la extracción de los gases en condiciones pesadas o de alta temperatura.

GMS-AU200	HP	Ø	L.	Temp.	Spec.
GMSAU-200	2,0	200 mm	5 m	200°C	GMNT-400200
GMSAU-200T5	2,0	200 mm	5 m	500°C	GMNT-400200
GMSAU-200T7	2,0	200 mm	5 m	700°C	GMNT-400200
GMSAU-200T1	2,0	200 mm	5 m	1000°C	GMNT-400200



GMSZ1







-  Miniset con aspiratore da 0,5 HP - 400V trifase 50Hz, 1,5 mt di calata rigida, tubo flessibile, mensola murale e bocchetta in gomma GRN.
-  Miniset with 0,5HP 400V 3PH 50HZ fan, 1,5 mt long pipe, hose, wall bracket and GRN rubber nozzle.
-  Miniset avec aspirateur de 0,5 HP - 400 V triphasée 50Hz, 1,5 mt de tuyau, flexible, console murale et entonnoir en caoutchouc GRN.
-  Miniset mit 0,37 kw Ventilator 400V 3PH 50HZ, 1,5 mt Rohr, Schlauch, Wandkonsole und GRN Gummitrichter.
-  Miniset completo de aspirador 0,5 HP - 400V trifasico 50Hz, 1,5 mt de tubo vertical, manguera, soporte a pared y boquerel en goma GRN.

GMSZ1	HP	Ø	L.	Spec.
GMSZ1755	0,5	75 mm	5 m	GRN
GMSZ1757	0,5	75 mm	7,5 m	GRN
GMSZ11005	0,5	100 mm	5 m	GRN
GMSZ11007	0,5	100 mm	7,5 m	GRN

GMSZ2



-  Miniset doppio con aspiratore, 1,5 mt di calata rigida, 2 tubi flessibili, mensole murali e bocchette in gomma GRN.
-  Double miniset with fan, 1,5 mt long pipe, 2 hoses, wall brackets and GRN rubber nozzles.
-  Double miniset avec aspirateur, 1,5 mt de tuyau, 2 flexibles, consoles murales et entonnoirs en caoutchouc GRN.
-  Doppel Miniset mit Ventilator, 1,5 mt Rohr, 2 Schläuche, Wandkonsolen und GRN Gummitrichtern.
-  Miniset doble completo de aspirador, 1,5 mt de tubo vertical, 2 mangueras, soportes a pared y boquereles en goma GRN.

GMSZ2	HP	Ø	L.	Spec.
GMSZ2755	0,5	75 mm	5 m	GRN
GMSZ2757	0,5	75 mm	7,5 m	GRN
GMSZ21005	1	100 mm	5 m	GRN
GMSZ21007	1	100 mm	7,5 m	GRN

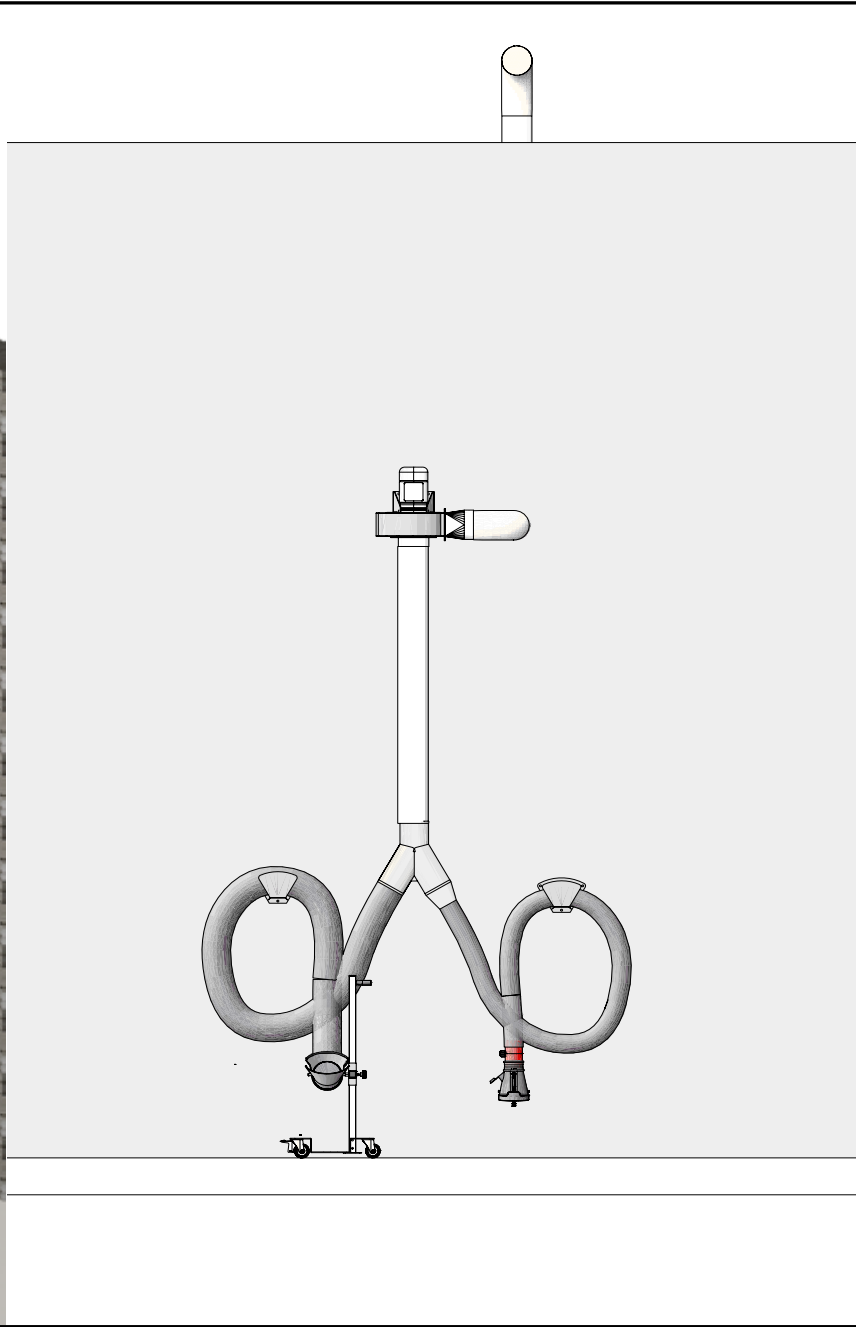

WORKY	
per approvazione / for approval	

Note / Notes	
Committenza / Final Customer	

Progettista / Designer	
Davide Menozzi	
Distributore / Dealer	
Distributore / Dealer	
Progetto / Project	Data / Date
_____	_____
Scala / Scale	Rev.
_____	0
Progettista / Designer	
Davide Menozzi	
Approvato / Approved	
Revisionato / Reviewed	

GTD

 Gas Telescopic Drop è un prodotto tanto semplice quanto funzionale. Il suo design pulito ed elegante racchiude 5 mt di tubo flessibile con bocchetta per arrivare ad attaccarsi alla marmitta del veicolo. Il tubo compattato dentro alla calata rigida ma lievemente basculante, riesce ad allungarsi fisarmonica fino al punto desiderato. A fine lavoro, quando l'operatore chiude la serranda della bocchetta, sentirà un utile effetto di richiamo del tubo nel suo alloggiamento verticale dato dalla forza dell'aspiratore. Agganciata la bocchetta al suo supporto, si può spegnerere l'aspiratore e l'impianto rimane fuori dalla zona di lavoro. Comodo, funzionale, economico.

 Gas Telescopic Drop is as simple as it is functional. Its clean and elegant design encloses 5 m of hose with a nozzle to attach to the vehicle's muffler. The hose is compacted inside the rigid but slightly tilting drop, and is able to extend to the desired point. At the end of the job, when the operator closes the valve of the nozzle, he will feel a useful pull-back effect of the hose in its vertical housing given by the force of the fan. Once the nozzle is attached to its holder, the fan can be switched off and the system remains outside the working area. Convenient, functional, economical.

 Gas Telescopic Drop est aussi simple que fonctionnel. Son design simple et élégant renferme 5 m de flexible avec un entonnoir à fixer sur le pot d'échappement du véhicule. Le flexible est compacté à l'intérieur de la tombé rigide mais légèrement basculante, et peut s'étendre jusqu'à l'endroit souhaité. À la fin du travail, lorsque l'opérateur ferme le registre de l'entonnoir, il ressent un effet utile de recul du flexible dans son logement vertical, dû à la force de l'aspirateur. Une fois l'entonnoir est fixée à son support, l'aspirateur peut être éteint et le système reste en dehors de la zone de travail. Pratique, fonctionnel, économique.

 Gas Telescopic Drop ist ebenso einfach wie funktionell. Sein elegantes Design umschließt einen 5 m langen Schlauch mit einen Trichter, die am Auspuff des Fahrzeugs befestigt wird. Der Schlauch ist im Inneren des starren, aber leicht kippbaren Tropfens verdichtet und kann sich akkordeonartig bis zum gewünschten Punkt ausziehen. Am Ende der Arbeit, wenn der Bediener die Trichterklappe schließt, spürt er, wie der Schlauch durch die Kraft des Ventilators in sein senkrechtes Gehäuse zurückgezogen wird. Sobald der Trichter platz gefunden hat, kann der Staubsauger ausgeschaltet werden. Bequem, funktionell, günstig.

 Gas Telescopic Drop es tan sencillo como funcional. Su diseño limpio y elegante encierra 5 m de manguera con un boquere para acoplarle al silenciador del vehículo. La manguera se compacta dentro de la bajante, y es capaz de extenderse en forma de acordeón hasta el punto deseado. Al final del trabajo, cuando el operario cierra la tapa del boquere, sentirá un útil efecto de retracción de la manguera en su alojamiento vertical dado por la fuerza del aspirador. Una vez colocada la boquilla en su soporte, el aspirador puede ser apagado y el sistema permanece fuera del área de trabajo. Cómodo, funcional, económico.



GTD

 Calata telescopica fissa con 5 mt di tubo flessibile diam 100 mm resistente fino a 200°C e bocchetta in gomma con serranda di chiusura a tenuta stagna.

 Telescopic fixed drop with 5 m of hose diam. 100 mm resistant up to 200°C and rubber nozzle with shut-off closing valve.

 Descente fixe télescopique avec 5 m de flexible en diam. 100 mm résistant jusqu'à 200°C et entonnoir en caoutchouc avec registre étanche.

 Teleskopischer, fester Absaugpunkt mit 5m Schlauch DN 100 mm, der bis zu 200°C beständig ist, und Gummitrichter mit Absperklappe.

 Bajada fija telescópica con 5 m de manguera de 100 mm de diámetro resistente hasta 200°C y boquerel en goma con tapa de cierre.

GTD	Ø	L.	Spec.
GTD100GRN	100 mm	5 m	GRN
GTD100GRNG	100 mm	5 m	GRNG
GTD100GON	100 mm	5 m	GRN



via Masaccio, 15
42124 Reggio Emilia (RE) ITALY
Tel. +39 0522 1545193
vendite@worky-italy.com
sales@worky-italy.com

www.worky-italy.com

GTD-100GRN - technical datasheet

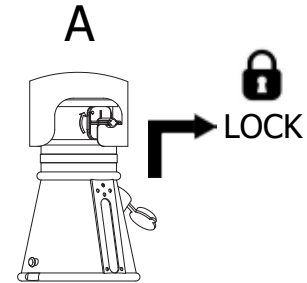
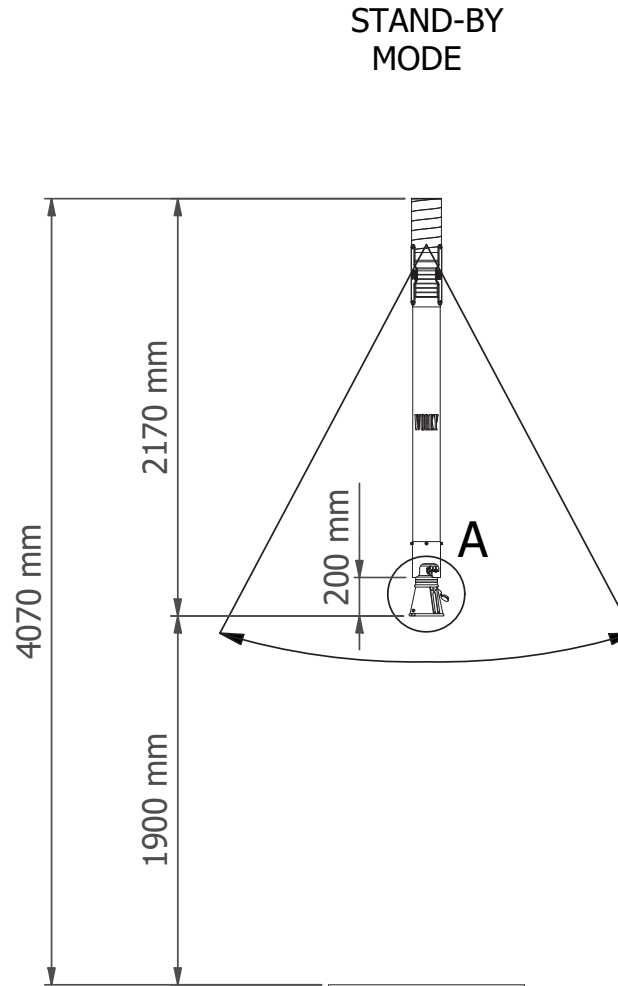
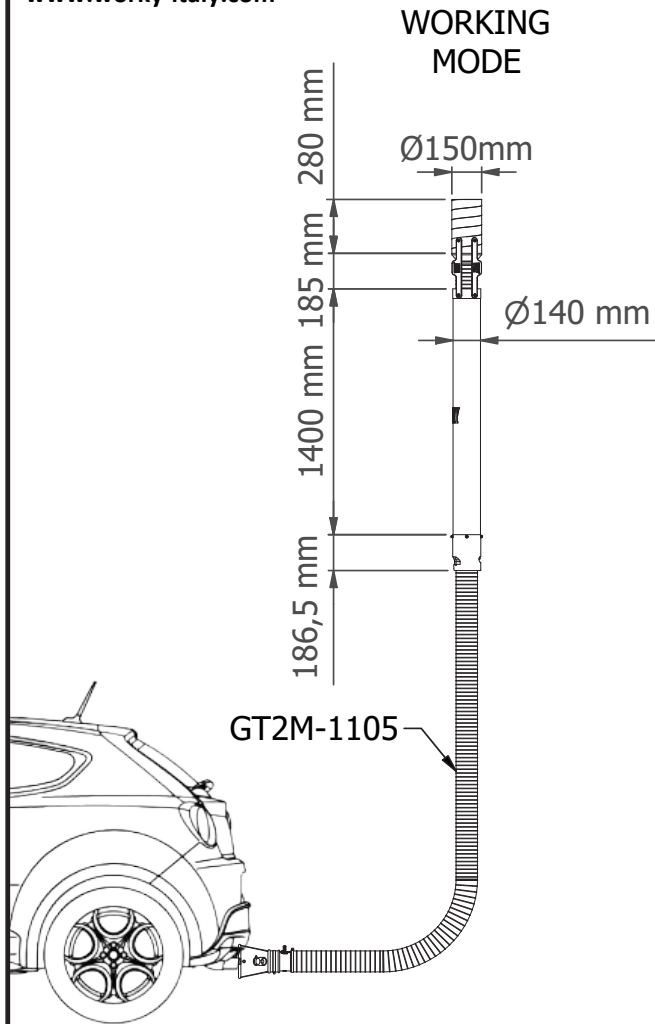

GRN-160100:

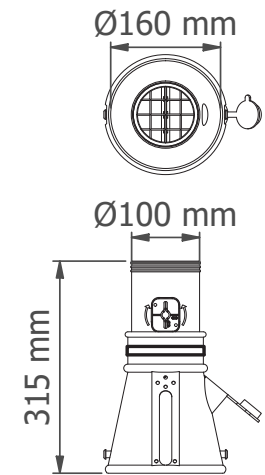

COD	PACK			Kg Tot
	l [mm]	w [mm]	h [mm]	
GTD-100GRN	2200	800	820	11

THIS DRAWING IS PROPERTY OF DEA + RO & Co S.p.A. THE COMPLETE OR PARTIAL REPRODUCTION OF THIS DOCUMENT IS FORBIDDEN. THE OWNER RESERVES THE RIGHT TO UPDATE, MODIFY OR AMEND ANY SPECIFICATION WITHOUT PRIOR NOTICE.

Rev.01

1/1
23/04/2025

CAT. ACCESS.

CAT. VENTILAT.

CAT. NOZZLES



SCAN THE QR CODE
DOWNLOAD THE
CATALOGUE



SCAN THE QR CODE
DOWNLOAD THE
CATALOGUE



SCAN THE QR CODE
DOWNLOAD THE
CATALOGUE



WORRY®

WORKY®

WORKY Headquarters and Production

Via Masaccio, 15 - Z.I. Mancasale
42124 - REGGIO EMILIA (RE) ITALY

Tel. +39-0522-1545193

Fax. +39-0522-1546451

sales@worky-italy.com

vendite@worky-italy.com

www.worky-italy.com

WORKY North America Inc.

112 South Tryon Street
Suite 1130 Charlotte, North Carolina
28284 USA

Tel +1 (305) 705 5017

www.deaworkyna.com



Inquadra il QR Code e scopri il nostro sito!
Frame the QR Code to discover our website!



Seguici su / Follow us on:



QUALITY CERTIFIED ISO 9001:2015